

User's Manual

EXTECH[®]
INSTRUMENTS

A FLIR COMPANY

**Wide Range Mini InfraRed Thermometer
with Laser Pointer**

MODEL 42510A

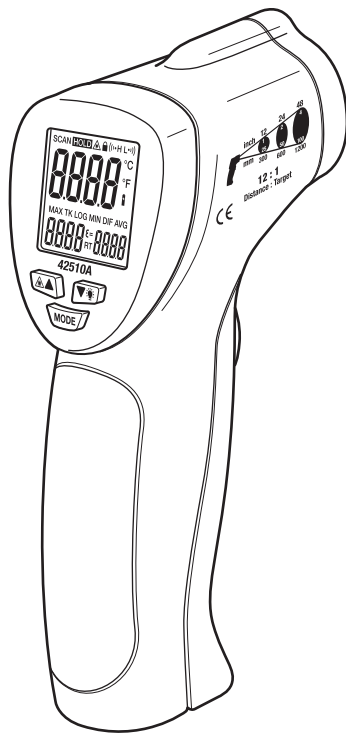

CE

Introduction

Congratulations on your purchase of the Model 42510A IR Thermometer. This Infrared thermometer measures and displays non-contact temperature readings up to 650°C (1200°F). The adjustable emissivity feature allows the IR thermometer to measure the temperature of virtually any surface. The built-in laser pointer increases target accuracy while the backlit LCD and handy push buttons combine for convenient, ergonomic operation. Operational functions include adjustable emissivity, high-low alarms, MIN-MAX memory, and trigger-lock test mode. This instrument is fully tested and calibrated prior to delivery, proper use and care of this meter will provide years of reliable service.

Safety

- Use extreme caution when the laser pointer is on
- Do not point the beam toward anyone's eye or allow the beam to strike the eye from a reflective surface
- Do not use the laser near explosive gases or in other potentially explosive areas

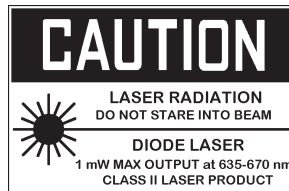



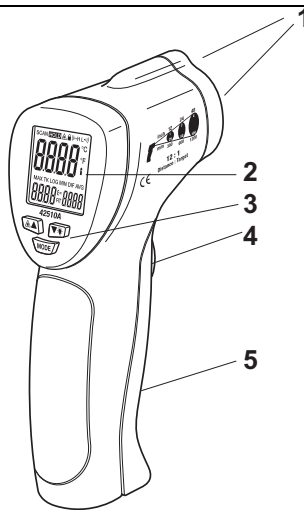

Description

1. IR Sensor and Laser pointer
2. LCD Display
3. Function Buttons
4. Measurement Trigger
5. Battery compartment



Function buttons

 (Laser) and  (UP) arrow button

 (Backlight) and  (DOWN) arrow button

MODE button

Display Description

1. SCAN, measurement in progress
2. HOLD, last measurement locked in display
3. Laser pointer active
4. Power locked ON
5. High limit alarm
6. Low limit alarm
7. C or F temperature units
8. Main temperature display
9. Low battery icon
10. MAX or MIN icon
11. Emissivity setting
12. Emissivity icon
13. MAX or MIN temperature display

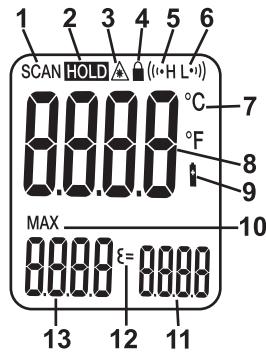



Operating Instructions

Temperature Measurements

1. Hold the meter by its handle and point it toward the surface to be measured.
2. Pull and hold the trigger to turn the meter on and begin testing. The temperature reading will change as the user scans various targets.
3. The 'SCAN' icon remains on until the user releases the trigger.
4. When the trigger is released, the reading will hold for approximately 7 seconds (HOLD will replace SCAN on the LCD) after which the meter will automatically shut off. The only exception to this is if the LOCK mode is set to ON.

Laser Pointer

The Laser pointer optimizes the user's aim during scanning. To turn the Laser on/off:

1. Press and release the Trigger
2. While HOLD is on the display, press the laser button  once to turn the Laser on or off.
3. The laser icon  will appear in the LCD when the Laser is on.
4. The status of the Laser is remembered by the meter and will remain as the ON condition until changed.

Backlight

1. Press and release the trigger
2. While HOLD is on the display, press the backlight button  once to turn the backlight on or off.
3. The backlight will illuminate the LCD when the feature is enabled.
4. The status of the backlight will be stored in memory and will remain as the ON condition until changed.
5. Note: The backlight will shorten the battery life; use sparingly and only as necessary.

Over-range Indication

If the temperature measurement exceeds the specified temperature range, the thermometer will display dashes in place of a temperature reading.

The MODE button options

The MODE button is used to access the emissivity adjustment, unit of measure selection, MAX-MIN feature, test-lock feature, and high-low alarms

1. Press and release the trigger
2. While HOLD is on the display, press the MODE button to enter the programming mode and to step through and configure the following features. A blinking icon indicates the feature is selected.

(Emissivity Value)

Press the ▲ or ▼ buttons to change the emissivity value from 0.10 to 1.00

(Units of Measure)

Use the ▲ and ▼ buttons to select the unit of measure.

(highest and lowest reading memory)

Press the ▲ or ▼ buttons to select MIN or MAX display

(Lock mode On/Off)

Press the ▲ or ▼ buttons to turn the lock feature ON or OFF.

(High Alarm On/Off)

Press the ▲ or ▼ buttons to turn the High Alarm feature ON or OFF.

(High Alarm setting)

Press the ▲ or ▼ buttons to set the high alarm limit value in the main display

(Low Alarm On/Off)

Press the ▲ or ▼ buttons to turn the High Alarm feature ON or OFF.

(Low Alarm setting)

Press the ▲ or ▼ buttons to set the Low alarm limit value in the main display.

Emissivity adjustment

An adjustable emissivity allows for accurate measurements on a variety of surface colors, textures, reflectivity, and finishes. The topic of emissivity is covered in greater detail in a subsequent section of this guide.

Temperature Units

The temperature units can be set to °F or °C in the programming mode using the ▲ and ▼ buttons

MAX (maximum) and MIN (minimum) Temperature display

The highest reading (MAX) or the lowest reading (MIN) encountered during a single measurement scan is displayed in the lower left-hand display area on the LCD. Select MIN or MAX in the programming mode using the ▲ and ▼ buttons

Lock feature

The LOCK feature disables the Auto Power Off feature for the period of use when selected. The feature is useful for long term temperature monitoring and hands free use. The meter will revert to auto power off if the trigger is pressed during a locked scan.

High and Low Alarm Feature

The meter has a programmable high and low alarm feature. When either alarm point is reached the meter will alert the user via an audible beep and a blinking LCD display icon. The alarm limit is set and the feature is enabled/disabled in the programming mode. The setting is stored and memory and will remain as the ON condition until changed.

IR Measurement Notes

1. The object under test should be larger than the spot (target) size calculated by the field of view diagram (printed on the side of the meter and in this guide).
2. Before measuring, be sure to clean surfaces that are covered with frost, oil, grime, etc.
3. If an object's surface is highly reflective, apply masking tape or flat black paint to the surface before measuring. Allow time for the paint or tape to adjust to the temperature of the surface it is covering.
4. Measurements through transparent surfaces such as glass may not be accurate.
5. Steam, dust, smoke, etc. can obscure measurements.
6. The meter automatically compensates for deviations in ambient temperature. However, it can take up to 30 minutes for the meter to adjust to extremely wide changes.
7. To find a hot spot, aim the meter outside the area of interest then scan across (in an up and down or side to side motion) until the hot spot is located.

Field of View

The meter's field of view is 12:1. For example, if the meter is 24 inches from the target (spot), the diameter of the target must be greater than 2 inches. Other distances are shown in the field of view diagram. Measurements should normally be made as close as possible to the device under test. The meter can measure from moderate distances but the measurement may be affected by external sources of light. In addition, the spot size may be so large that it encompasses surface areas not intended to be measured.

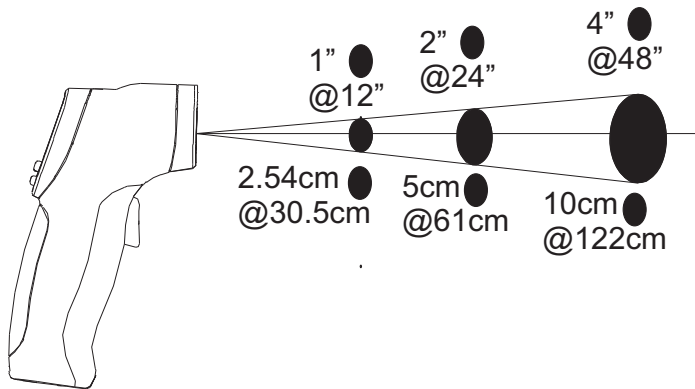

Emissivity and IR Measurement Theory

IR Thermometers measure the surface temperature of an object. The thermometer's optics sense emitted, reflected, and transmitted energy. The thermometer's electronics translate the information into a temperature reading which is then displayed on the LCD.

The amount of IR energy emitted by an object is proportional to an object's temperature and its ability to emit energy. This ability is known as emissivity and is based upon the material of the object and its surface finish. Emissivity values range from 0.1 for a very reflective object to 1.00 for a flat black finish. For the Model 42510A, the emissivity is adjustable from 0.1 to 1.00. Most organic materials and painted or oxidized surfaces have an emissivity factor of 0.95. When in doubt, set the emissivity to 0.95.

Emissivity Factors for Common Materials

Material under test	Emissivity	Material under test	Emissivity
Asphalt	0.90 to 0.98	Cloth (black)	0.98
Concrete	0.94	Skin (human)	0.98
Cement	0.96	Leather	0.75 to 0.80
Sand	0.90	Charcoal (powder)	0.96
Soil	0.92 to 0.96	Lacquer	0.80 to 0.95
Water	0.92 to 0.96	Lacquer (matt)	0.97
Ice	0.96 to 0.98	Rubber (black)	0.94
Snow	0.83	Plastic	0.85 to 0.95
Glass	0.90 to 0.95	Timber	0.90
Ceramic	0.90 to 0.94	Paper	0.70 to 0.94
Marble	0.94	Chromium Oxides	0.81
Plaster	0.80 to 0.90	Copper Oxides	0.78
Mortar	0.89 to 0.91	Iron Oxides	0.78 to 0.82
Brick	0.93 to 0.96	Textiles	0.90

Battery Replacement

When the low battery symbol  appears on the display, replace the meter's battery (9V). The battery compartment is located behind the panel that surrounds the meter's trigger. Open the compartment by pulling the panel down from the trigger area. Replace the 9V battery and close the battery compartment cover.



You, as the end user, are legally bound (**EU Battery ordinance**) to return all used batteries, **disposal in the household garbage is prohibited!** You can hand over your used batteries / accumulators at collection points in your community or wherever batteries / accumulators are sold!

Disposal: Follow the valid legal stipulations in respect of the disposal of the device at the end of its lifecycle

Specifications

Range / Resolution	0.1° resolution from -50.0 to 650.0°C (-58.0 to 999.9°F); 1° resolution from 538°F to 649°C
Accuracy	-50°C to -35°C (-58°F to -31°F) ±4°C/9°F -35°C to -2°C (-31°F to 28°F) ±3°C/5°F -2°C to 94°C (28°F to 200°F) ±2.5°C/3°F 94°C to 204°C (200°F to 400°F) ±(1.0%rdg + 1°C/2°F) 204°C to 426°C (400°F to 800°F) ±(1.5%rdg + 1°C/2°F) 426°C to 650°C (800°F to 1200°F) ±(2.0%rdg + 1°C/2°F) Note: Accuracy is specified for the following ambient temperature range: 18 to 28°C (64 to 82°F)
Emissivity	0.10 to 1.00 adjustable
Field of View	D/S = Approx. 12:1 ratio (D = distance; S = spot or target)
Laser pointer	Class 2 laser < 1mW power; Wavelength: 630 to 670nm
IR Spectral response	8 to 14 μm
Repeatability	± 0.5% of reading or ± 1°C/1.8°F; whichever is greater

General Specifications

Display	Backlit LCD display with function indicators
Response time	300ms
Over range indication	"-----"
Operating Temperature	0°C to 50°C (32°F to 122°F)
Operating Humidity	10% to 90%RH operating, <80%RH storage.
Storage Temperature	-10 to 60°C (14 to 140°F)
Power Supply	9V battery
Automatic Power Off	7 seconds, with LOCK to disable
Weight	6.4 oz. / 180g
Dimensions	82 x 42 x 160mm (3.2 x 1.6 x 6.3")

Copyright © 2010 Extech Instruments Corporation (a FLIR company)
All rights reserved including the right of reproduction in whole or in part in any form.